

AMR-OP60RH/xx RevA

Programmable on-wall controller

- Graphic blue/white LCD
- Measurement of temperature and ambient humidity
- Control via four buttons
- Modbus RTU / ARION (RS485) communication
- Design ABB Time / Time Arbo / Element
- Possibility of custom programming
- Power supply 24 V DC

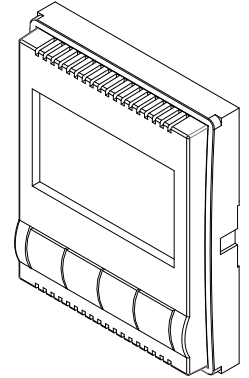

TECHNICAL DATA

Display	Graphic blue/white LCD
Resolution	(256 × 128) pixels (non-symmetric point)
Display area	(44 × 25) mm
Backlight / lifetime	LED / min. 50,000 hours ¹⁾
Temperature and humidity measurement	Digital sensor
Measurement range temperature / humidity	-10 °C to 50 °C / 20 % to 80 %
Temperature measurement accuracy	±0.5 °C
Humidity measurement accuracy	±2.5 %
RH 20 % to 60 %	±{2.5 + [(RH - 60)/10]} %
RH 60 % to 80 %	
Stabilisation time	45 min.
Control	4× button
Communication	RS485
Galvanic isolation	No
Number of units in a RS485 segment	256
RS485 wires termination	External resistor ²⁾
Power supply	10 V DC to 30 V DC
Maximum consumption	40 mA at 24 V DC
Other	
Ingress protection rate	IP20
Operating temperature range	-10 °C to 50 °C
Maximum ambient humidity	< 95 % non-condensing
Mounting	Into a KU68 mounting box with a frame
Frame design ²⁾	ABB Time / Time Arbo / Element
Weight	60 g
Dimensions (w × h × d)	(71 × 71 × 28) mm ³⁾
Application program	TA_OP60RH_FW01AM_xxx
Programming	DetStudio / EsiDet

¹⁾ Backlight intensity drop to 50 %

²⁾ Not included in the delivery

³⁾ Final dimensions depend on the frame type

ORDERING INFORMATION

AMR-OP60RH/xx RevA¹⁾	On-wall controller with a pre-loaded application software
RR 120R	External terminating resistor for RS485

¹⁾ xx denotes the colour version, see the table on the next page.

Note: The application program is available for download at amitautomation.com.

Designation	Colour version
AMR-OP60RH/01 RevA	White / ice white, Time/Element
AMR-OP60RH/03 RevA	White / white, Time/Element
AMR-OP60RH/08 RevA	Titanium, Time
AMR-OP60RH/32 RevA	Old silver, Time
AMR-OP60RH/33 RevA	Champagne, Time
AMR-OP60RH/34 RevA	Anthracite, Time
AMR-OP60RH/36 RevA	Steel, Time

Note: Small recesses on the surface and colour inhomogeneity do not justify a warranty claim.

TERMINALS IDENTIFICATION

Terminal	Description	Significance
1	V+	Power supply +24 V DC
2	G	Ground
3	B	RS485 interface, signal B
4	A	RS485 interface, signal A

Note: If the **AMR-OP60RH/xx RevA** is a terminal station on the RS485 line, it is necessary to connect an external terminating resistor – **RR 120R** (not included in the delivery) – between terminals 3 and 4.

RECOMMENDED DRAWING SYMBOL

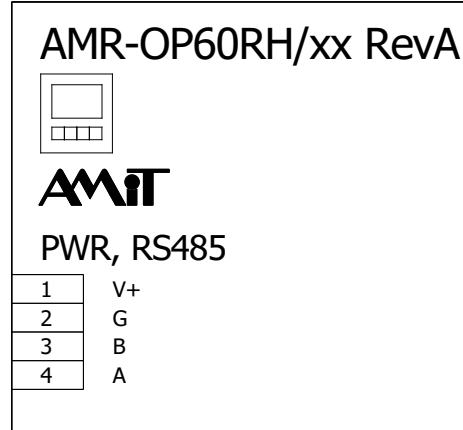

LOCATIONS OF TERMINALS

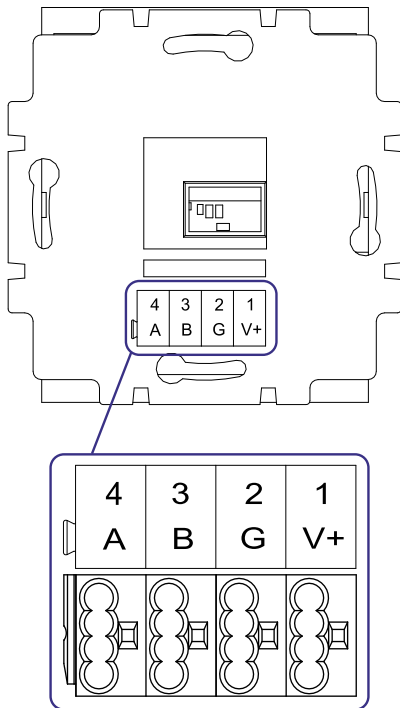

MECHANICAL DIMENSIONS

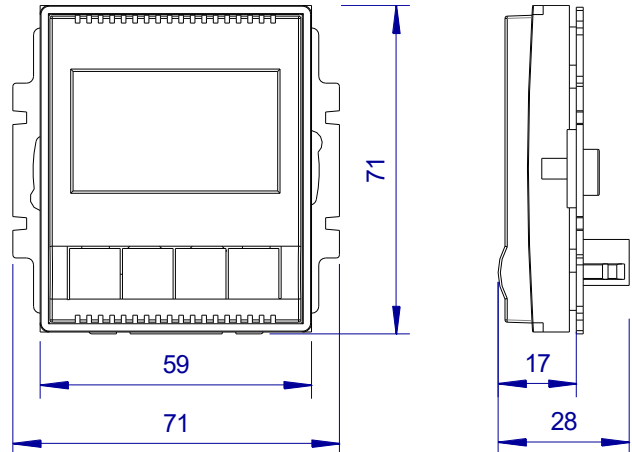

AMR-OP60RH/xx RevA

Programmable on-wall controller

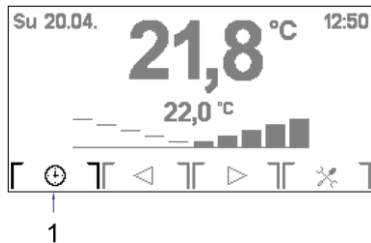

CONTROL VARIANTS

Variant 1



Room mode (1) + correction

The icon (1) signifies the selected room mode. Pressing the button below the icon cycles through three states.

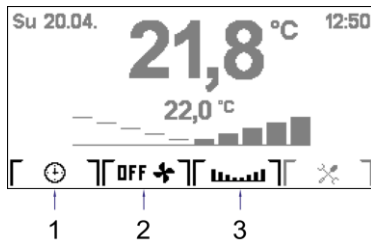

Icon	Significance	Description
	Comfort	Regulation to a constant (comfortable) temperature.
	Energy-saving	Regulation to a constant (energy-saving) temperature.
	Auto	Regulates according to a set time plan modified by the correction.

Variant 2







Room mode (1), fan mode (2), correction (3)

The icon (1) signifies the selected room mode. Pressing the button below the icon cycles through three states.

Icon	Significance	Description
	Comfort	Regulation to a constant (comfortable) temperature.
	Energy-saving	Regulation to a constant (energy-saving) temperature.
	Auto	Regulates according to a set time plan modified by the correction.

The icon (2) signifies the selected fan mode. Pressing the button below the icon cycles through five states.

Icon	Significance	Description
	OFF	The fan is off.
	Auto	The fan is controlled automatically.
	Speed 1	The fan is set to speed 1.
	Speed 2	The fan is set to speed 2.
	Speed 3	The fan is set to speed 3.

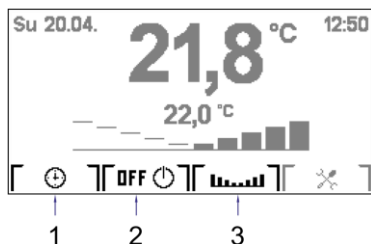

The icon (3) opens a screen for setting the correction of the room temperature setpoint (displayed only in the **Auto** mode).

Variant 3





Room mode (1), switch (2), correction (3)

The icon (1) signifies the selected room mode. Pressing the button below the icon cycles through three states.

Icon	Significance	Description
	Comfort	Regulation to a constant (comfortable) temperature.
	Energy-saving	Regulation to a constant (energy-saving) temperature.
	Auto	Regulates according to a set time plan modified by the correction.

The icon (2) signifies the switch status. Pressing the button below the icon cycles through two states.

Icon	Significance	Description
	Off	The switch is off.
	On	The switch is on.

The icon (3) opens a screen for setting the correction of the room temperature setpoint (displayed only in the **Auto** mode).

OPERATION OF THE AMR-OP60RH/xx RevA controller

Home screen

The appearance of the home screen depends on the set type application. The type is selected by the service company during the controller installation. One section of the home screen is common for all types, and one depends on the selected FW settings.

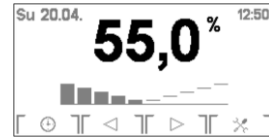

Common features

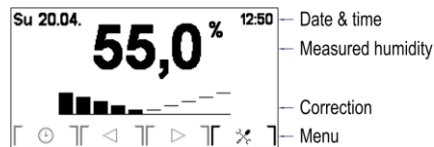
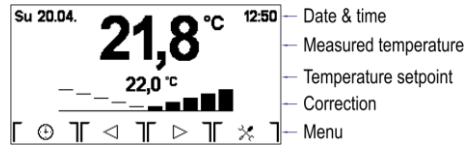

Date & time

Time and date is sent by the superior system. The left corner displays the date, the right one displays the time of the superior system.

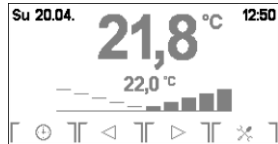

Measured temperature

The way the measured temperature is displayed depends on the setting of the respective item in the configuration menu.

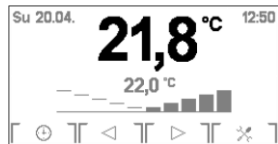

Temperature setpoint

The temperature value is sent by the superior system. In case the correction setting changes, dashes are shown until a new setpoint value is received from the superior system. The value may appear with a delay of several seconds.

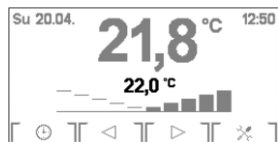

Measured humidity

The way the measured humidity is displayed depends on the setting of the respective item in the configuration menu.

Correction

The correction bar-graph (in Variants 2 and 3, there's also the [] – the corresponding button than opens a correction setting screen) is displayed only in the **Auto** room mode. It is hidden in other modes (**Energy-saving** and **Comfort**).

Pressing the buttons below icons [] or [] adds to or subtracts from the correction value. After each correction change, dashes appear instead of the temperature setpoint until a new temperature setpoint value is received from the superior system.

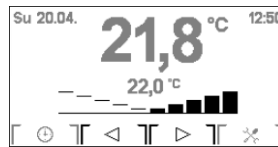

User menu

The user menu is displayed by pressing the button below the [] icon.



The significance of buttons below icons is following:

Icon	Significance
[Esc]	Exits the screen.
[v]	Scrolls the menu up.
[^]	Scrolls the menu down.
[Enter]	Selects an item and opens a screen.

Menu items

Other available items:

- Brightness
- Contrast
- Language
- Display
- Info

Brightness

is used to set the display brightness.

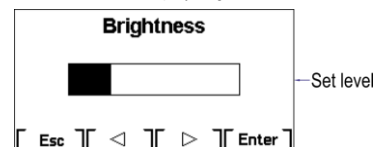

The significance of buttons below icons is following:

Icon	Significance
[Esc]	Exits the screen without saving.
[<]	Decreases brightness.
[>]	Increases brightness.
[Enter]	Confirms and exits the screen.

Contrast

is used to set the display contrast.

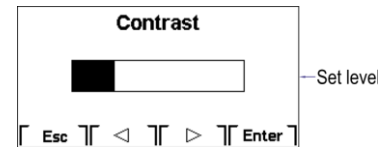

The significance of buttons below icons is following:

Icon	Significance
[Esc]	Exits the screen without saving.
[<]	Decreases contrast.
[>]	Increases contrast.
[Enter]	Confirms and exits the screen.

Language

is used to toggle between Czech and English user interface of the controller.

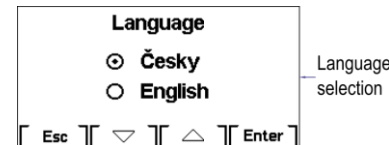

The significance of buttons below icons is following:

Icon	Significance
[Esc]	Exits the screen without saving.
[v]	Next language.
[^]	Previous language.
[Enter]	Confirms and exits the screen.

Display

is used to set the screen saver.



The significance of buttons below icons is following:

Icon	Significance
[Esc]	Exits the screen without saving.
[v]	Decreases time value.
[^]	Increases time value.
[Enter]	Confirms and exits the screen.

Binding detailed information can be found in the operation manual (amr-op60rhxx_reva_g_en_xxx.pdf). Documentation and examples are available www.amitotation.com.

Following values can be set:

Value	Significance
-1	Screen saver is off.
10 to 120	Time it takes for the screen saver to activate (in seconds).

Info

Selecting **Info** shows the current application software version of the on-wall controller.



Screen saver

When screen saver timer is set (via the **Display** item in the user menu), the screen saver appears after the pre-set idle time (the screen saver screen opens and the display backlight turns off).

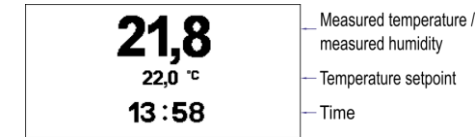

Values of temperature and humidity are displayed depending on the set view mode of the measured values in the configuration menu.

Tapping the screen once turns on the backlight; tapping it twice displays the home screen.

Communication failure/Restart

When communication with the superior system fails or a restart occurs, the [] icon appears below the measured value.

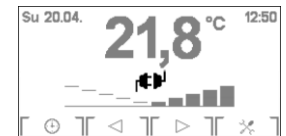

AMIT, spol. s r. o. hereby proclaims that AMR-OP60RH/xx RevA meets the basic requirements and other provisions of Directive 1999/5/ES.



Note: Although this product contains no toxic or otherwise harmful substances, dispose of it via a centre for recycling electronic waste.